

DEKUPS® HOW TO USE THE SYSTEM

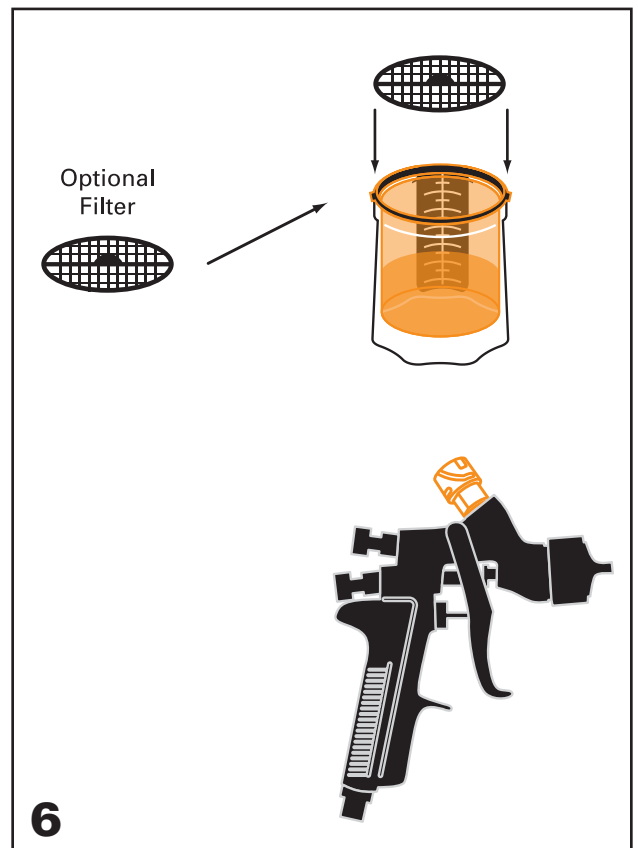

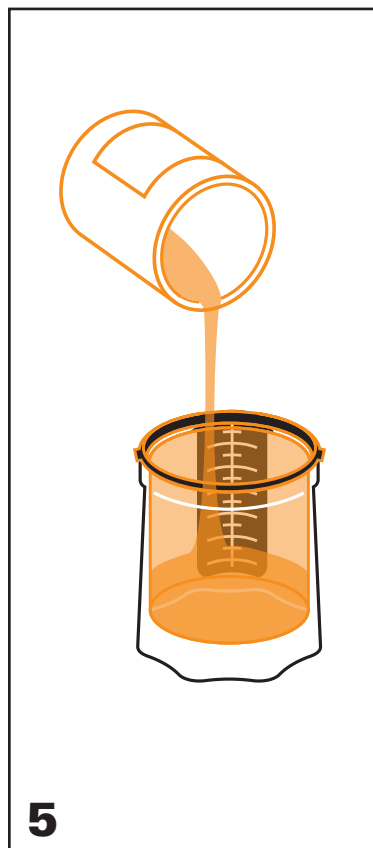

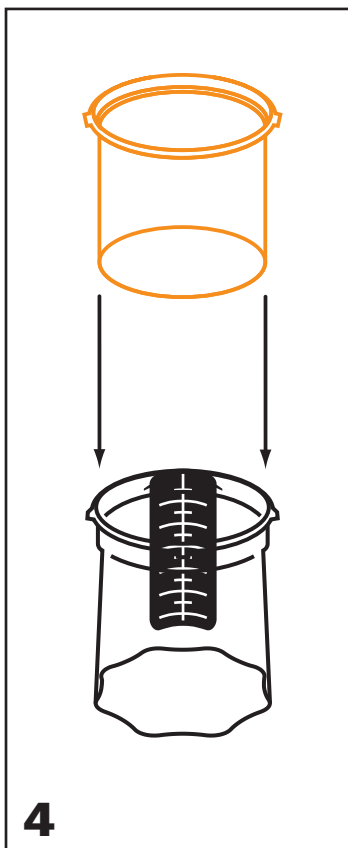

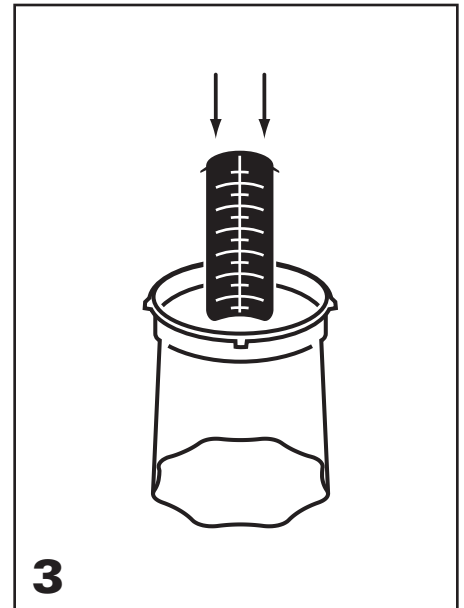
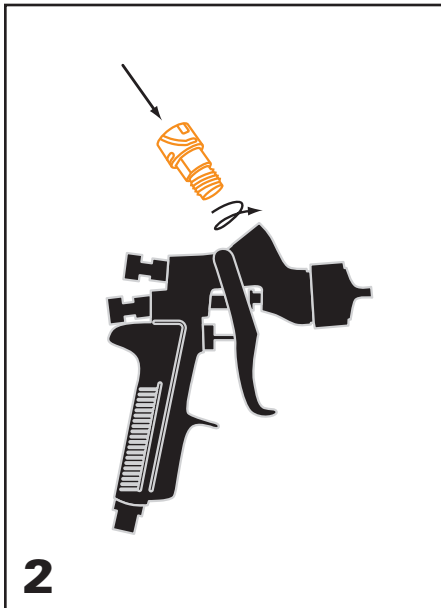
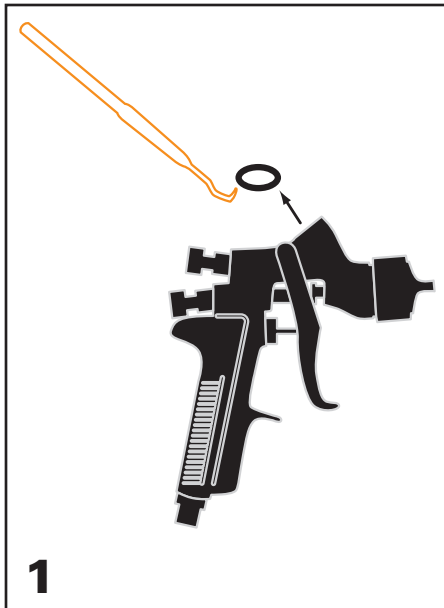
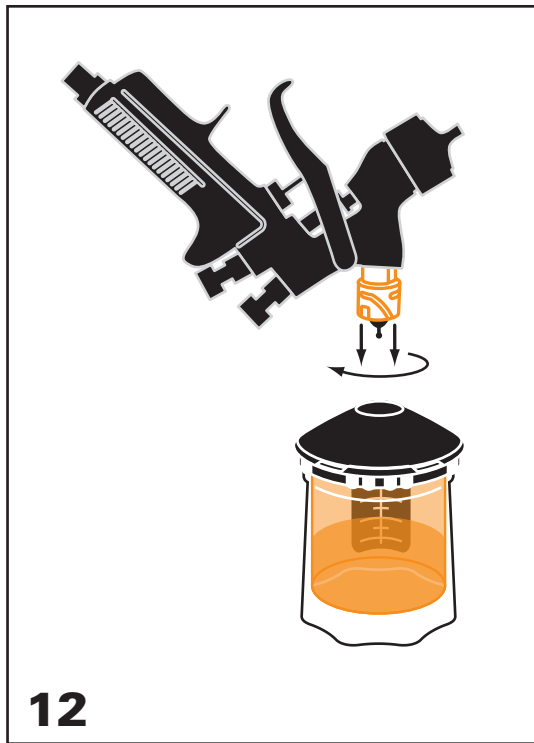
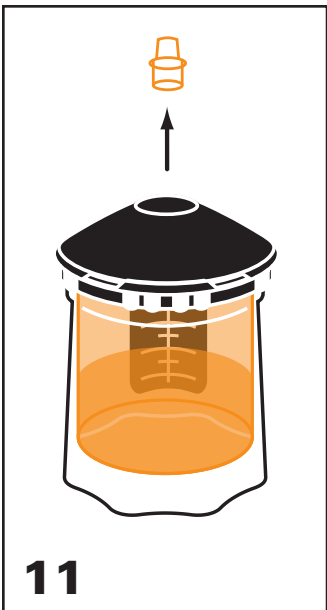
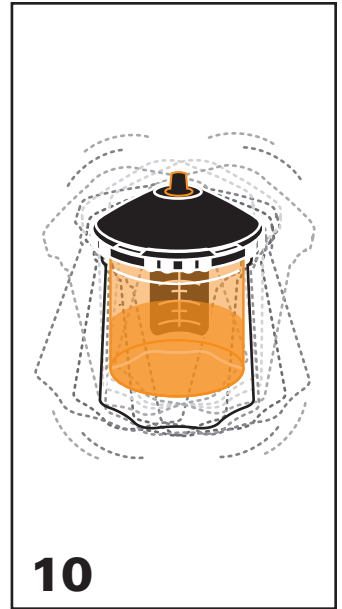
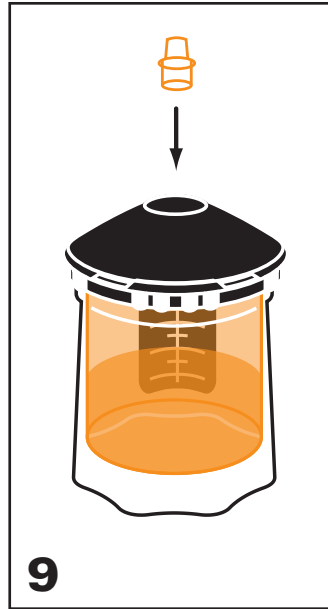
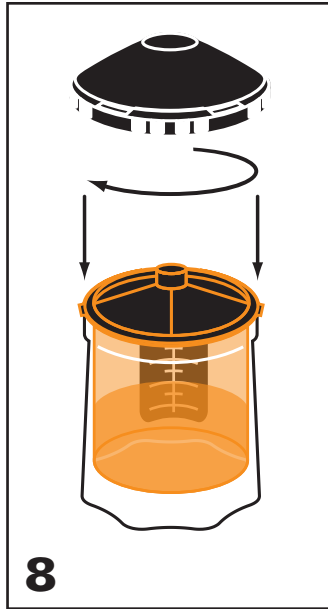
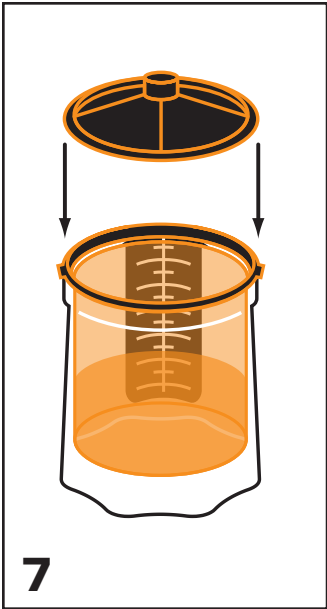
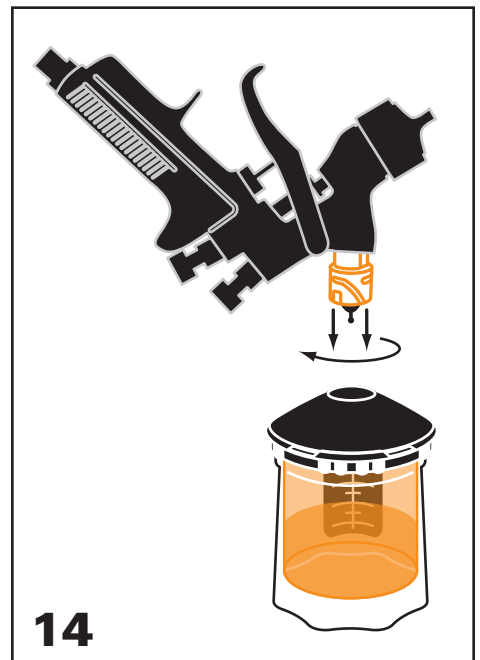
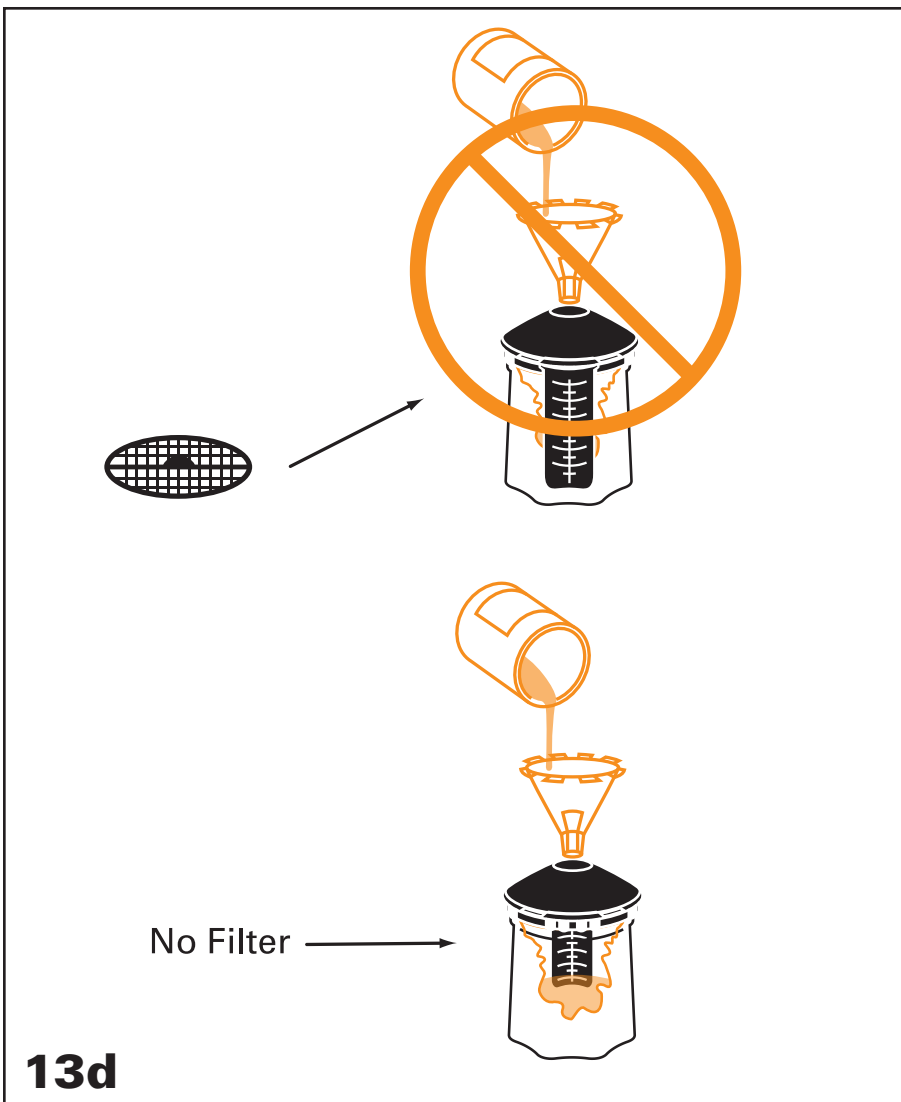
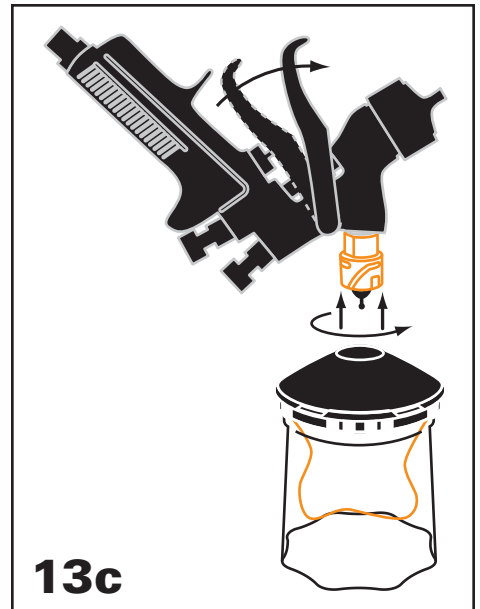
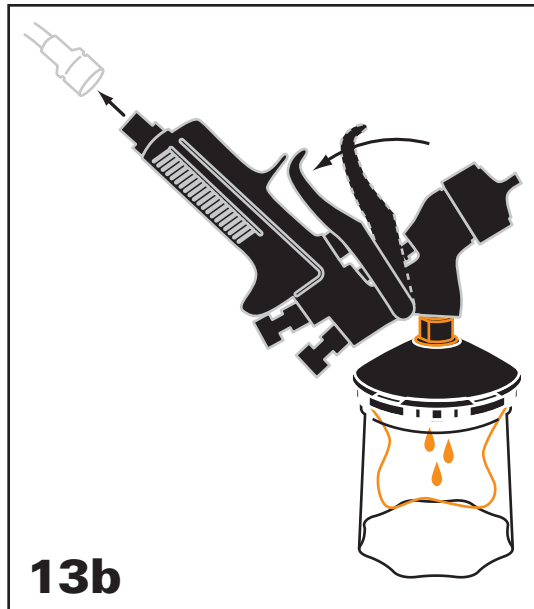
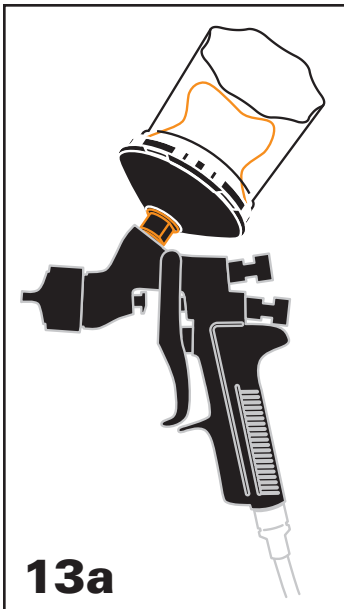
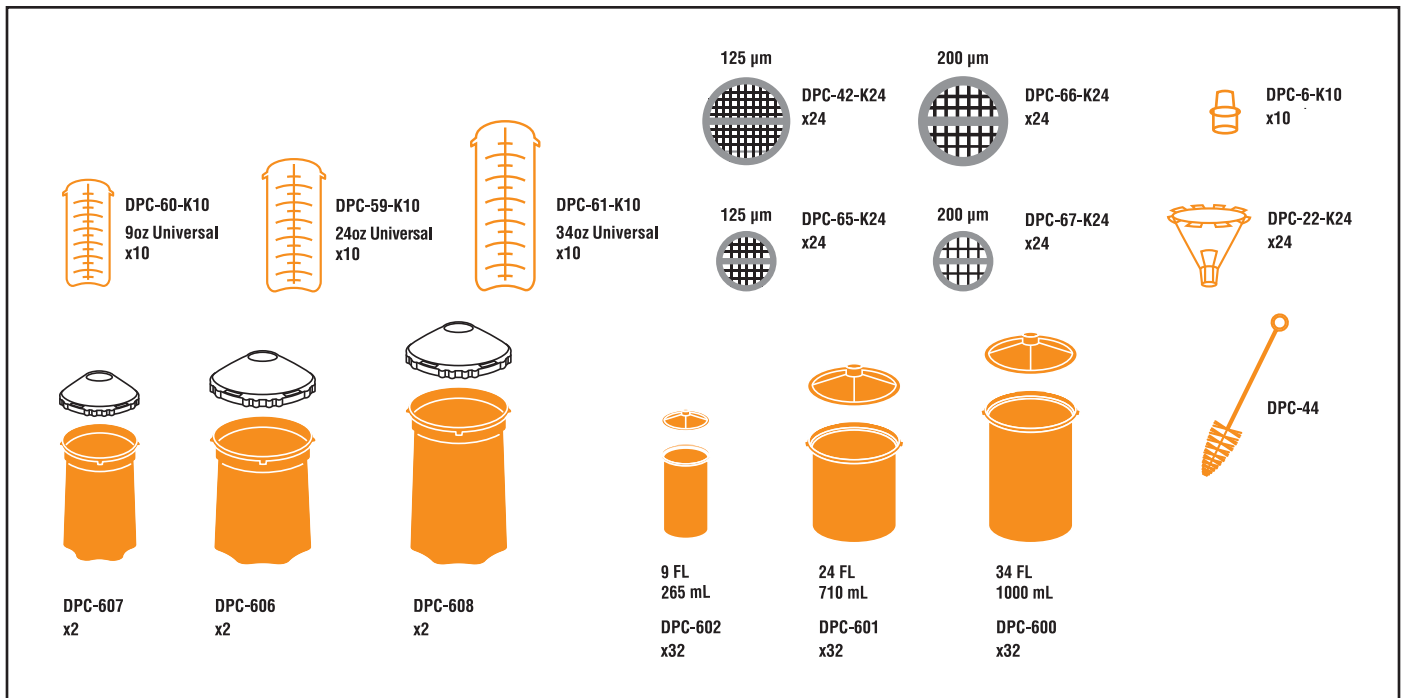

WARRANTY

This product is covered by DeVilbiss' 1 Year Limited Warranty.

DeVilbiss Sales and Service: www.devilbiss.com



U.S.A./Canada Customer Service
 Finishing Equipment Americas
 195 Internationale Blvd.
 Glendale Heights, IL 60139
 630-237-5000

Toll Free Customer Service
 and Technical Support
 800-992-4657
 Toll Free Fax
 888-246-5732

U.S. Patent Numbers 7,086,549; 7,344,040;
 7,353,964 owned by Inc. and
 U.S. Patent Numbers 6,820,824; 7,374,111 owned
 by 3M Innovative Properties Co.